

TRADES EXHIBITION HALL

CONSTRUCTION KIT INSTRUCTION MANUAL



Follow along with
instructional videos at
www.nscsc.ca/TEHConstructionKit



Or scan
this QR
code to
access the
webpage.



Nova Scotia
Construction Sector Council
Industrial ~ Commercial ~ Institutional



NOVA SCOTIA
APPRENTICESHIP
AGENCY



PIECES & PARTS

WINDOW PARTS (FOR 3 WINDOWS)

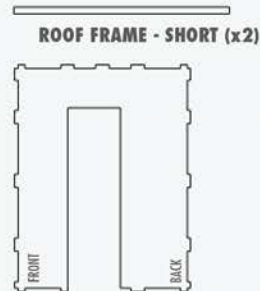
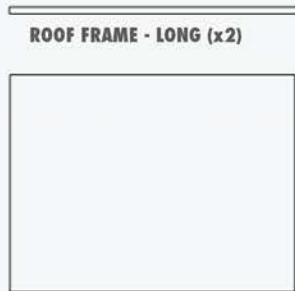
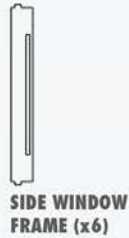
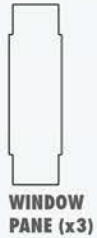

DOOR FRAME PARTS

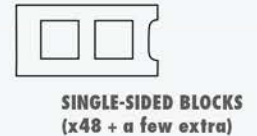
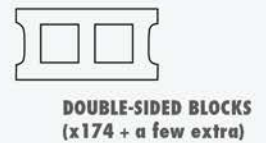
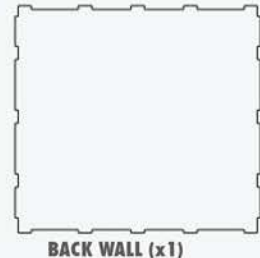
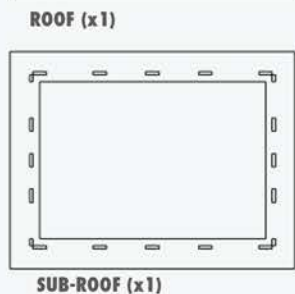
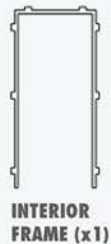

DOOR PARTS

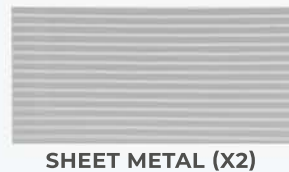
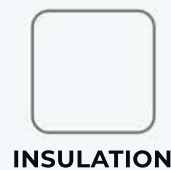
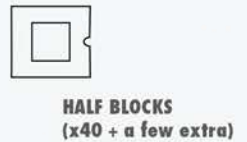
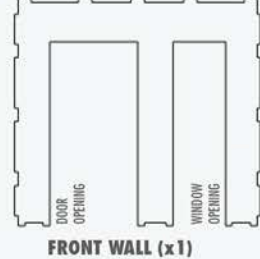
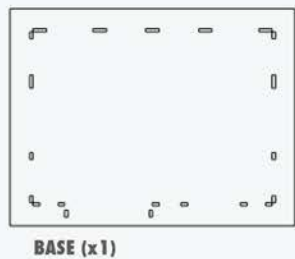
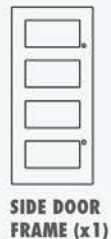
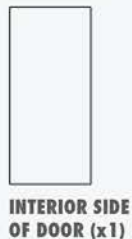

ADDITIONAL MATERIALS



Follow along with instructional videos at
www.nscsc.ca/TEHConstructionKit



Nova Scotia
Construction Sector Council
Industrial ~ Commercial ~ Institutional

TRADES EXHIBITION HALL

CONSTRUCTION KIT
INSTRUCTION MANUAL
PAGE 2

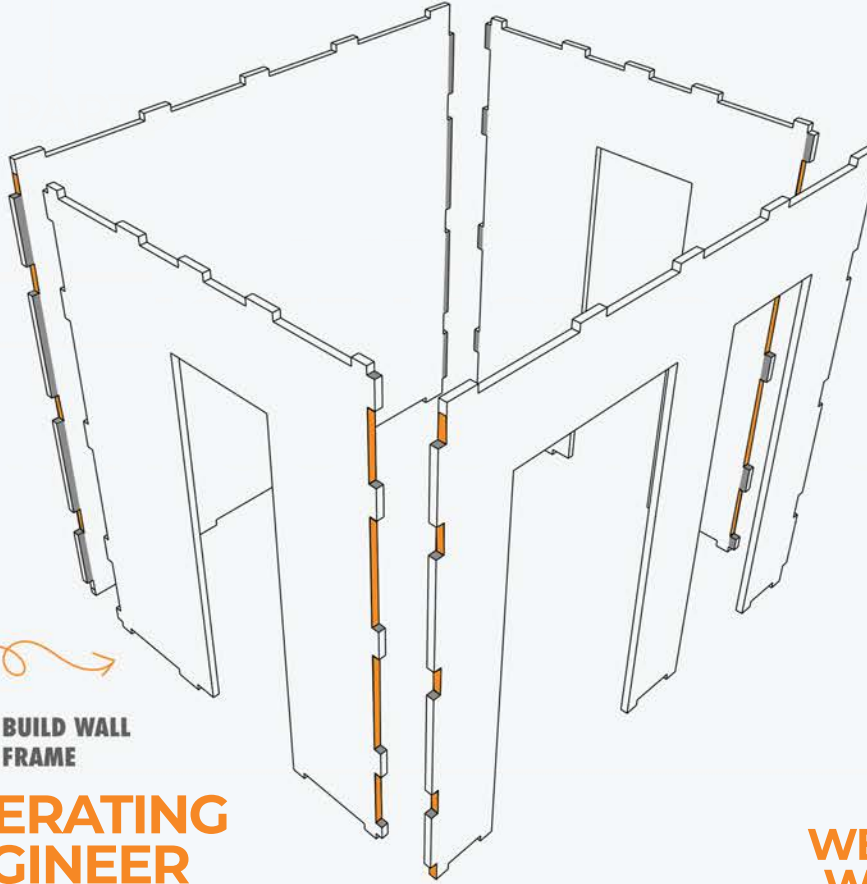

1 BUILD WALL
FRAME

**OPERATING
ENGINEER**



**PLEASE
WEAR GLOVES
WHEN USING
SUPER GLUE**

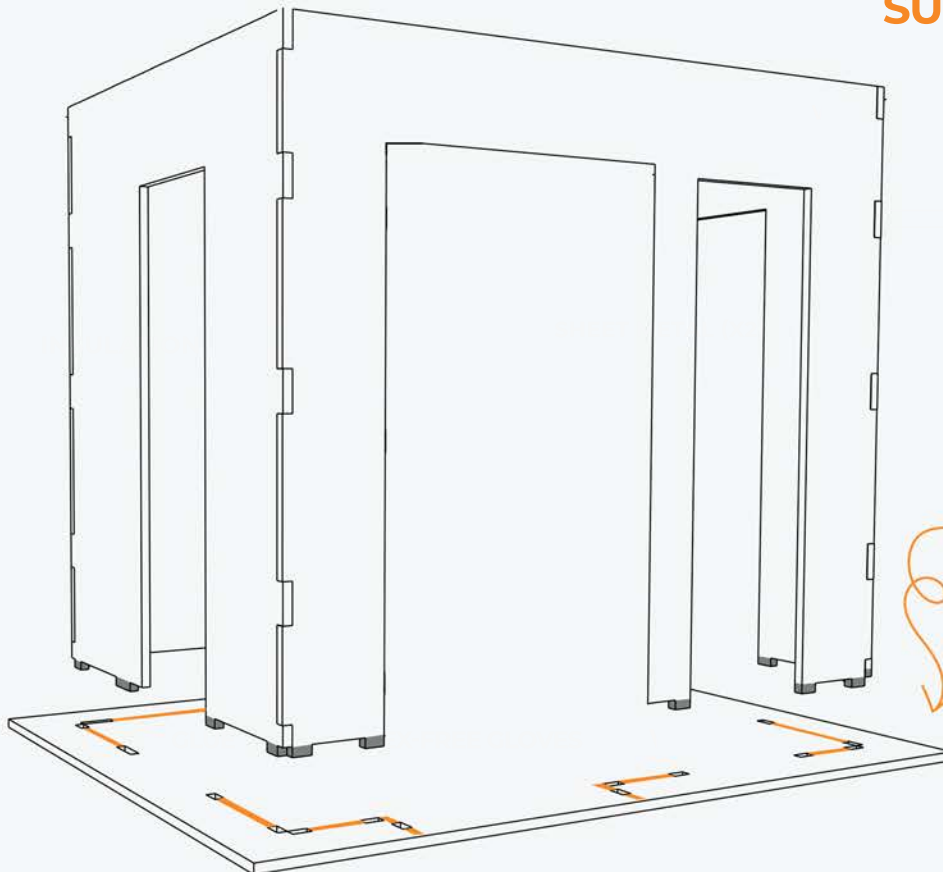

1b. ATTACH
COMPLETED
WALL
FRAME TO
BASE

CARPENTER



2 ATTACH SUBROOF
TO WALL FRAME

CARPENTER

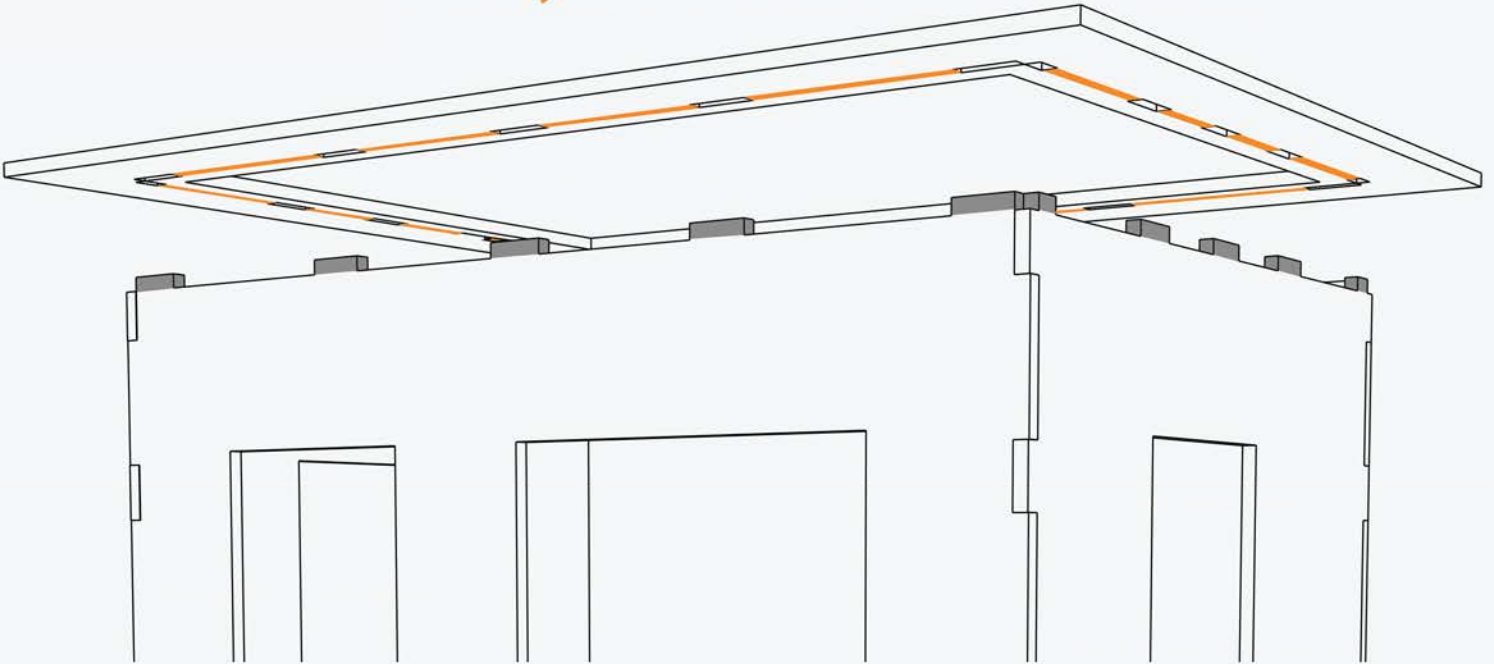

**PLEASE
WEAR GLOVES
WHEN USING
SUPER GLUE**

3 BUILD THE DOOR
FRAME

CARPENTER

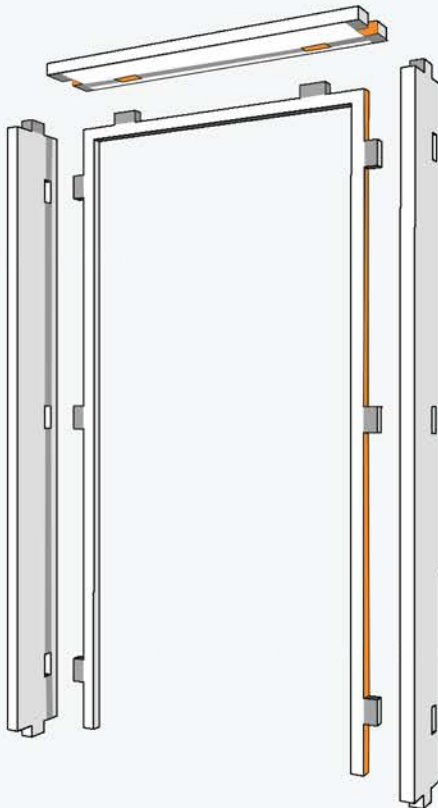



Nova Scotia
Construction Sector Council
Industrial ~ Commercial ~ Institutional

TRADES EXHIBITION HALL

CONSTRUCTION KIT
INSTRUCTION MANUAL
PAGE 4

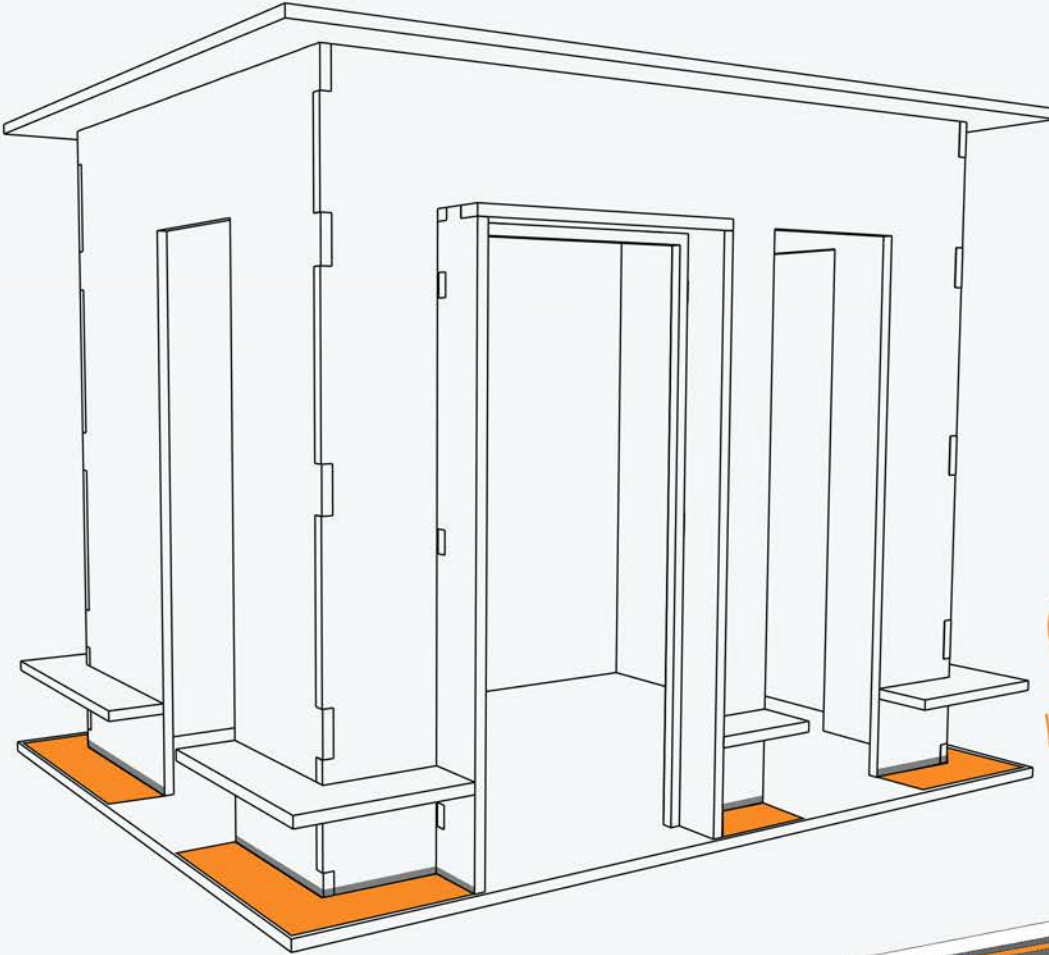

4

**ATTACH THE
BOTTOM TRIM
TO BASE**

CARPENTER



**PLEASE
WEAR GLOVES
WHEN USING
SUPER GLUE**



5

**BUILD
WINDOWS (x3)**

**FINISHING
TRADES**

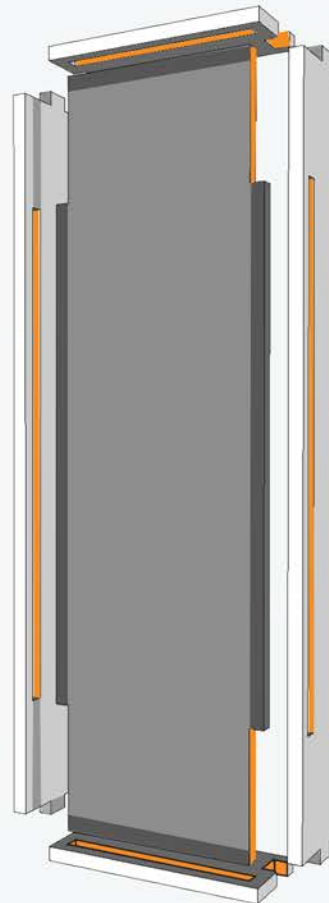

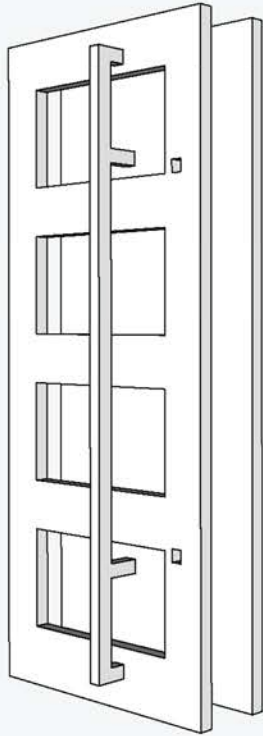

**PLEASE
WEAR GLOVES
WHEN USING
SUPER GLUE**

←
**BUILD THE
FRONT DOOR 6**

CARPENTER



←
**7 INSTALL
WINDOWS**

**FINISHING
TRADES**



**PLEASE NOTE:
DO NOT GLUE
THE FRONT DOOR
INTO PLACE IF YOU
WANT TO USE IT.**

←
**7b. ADD FRONT
DOOR**

CARPENTER



TIPS

- IF YOU HAVEN'T ALREADY DONE SO, REFER TO THE "PIECES AND PARTS" PAGE TO MAKE SURE THAT YOU HAVE THE CORRECT AMOUNT OF CINDER BLOCKS. YOU WILL NOTICE THAT WE HAVE GIVEN YOU A FEW EXTRAS JUST IN CASE THERE ARE ANY HICCUPS WHILE YOU ARE BUILDING.
- GET FAMILIAR WITH THE "KEY" ON THE RIGHT SIDE OF THIS PAGE AND THE VISUAL LAYOUT BELOW SO YOU KNOW WHERE TO PLACE THE CINDER BLOCKS.
- START WITH THE BOTTOM LAYER FIRST! LAY OUT ONE WHOLE LAYER OF CINDER BLOCKS BEFORE YOU BEGIN ATTACHING TO MAKE SURE YOU HAVE A PERFECT FIT. FOR EXAMPLE, SINCE WE RECOMMEND STARTING WITH THE BOTTOM ROW FIRST, IT WOULD BE A GOOD IDEA TO LAY OUT THE CINDER BLOCKS NEEDED ALONG THE BOTTOM ON ALL SIDES AND THEN BEGIN ATTACHING THEM ONE BY ONE. MOVE ON TO THE SECOND ROW AND LAY IT OUT COMPLETELY ON ALL SIDES, AND SO ON...
- USE MORTAR TO FILL THE GAPS. YOU WILL FIND SPACE BETWEEN THE BLOCKS.

Key:

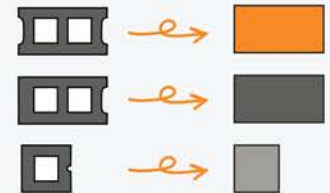

8 INSTALL BRICKWORK BRICK LAYER

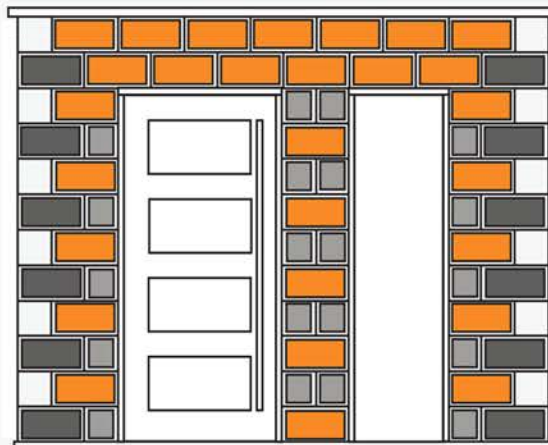

FRONT

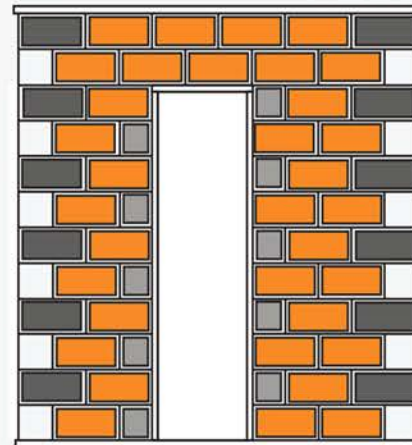

RIGHT

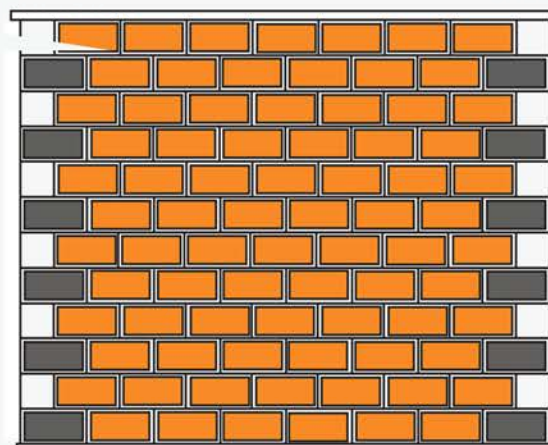

BACK

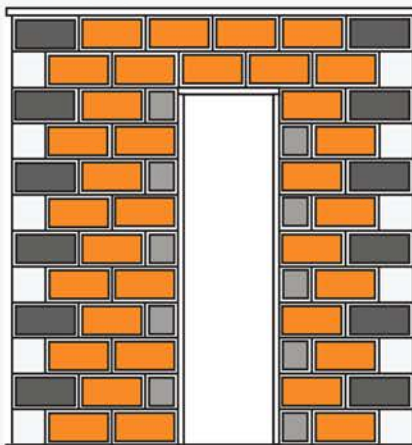

LEFT



9 ADD THE ROOF TRIM
CARPENTER



**PLEASE
WEAR GLOVES
WHEN USING
SUPER GLUE**

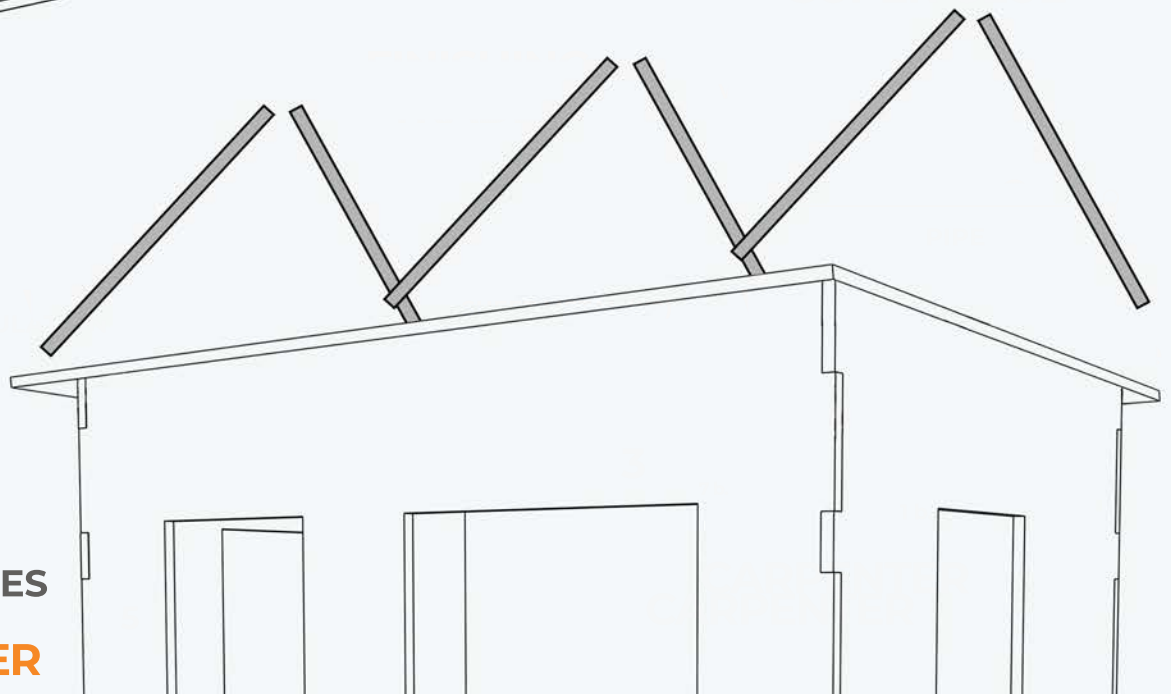

10
ADD THE
ROOF TRUSSES

IRON WORKER



Nova Scotia
Construction Sector Council
Industrial ~ Commercial ~ Institutional

TRADES EXHIBITION HALL

CONSTRUCTION KIT
INSTRUCTION MANUAL
PAGE 8

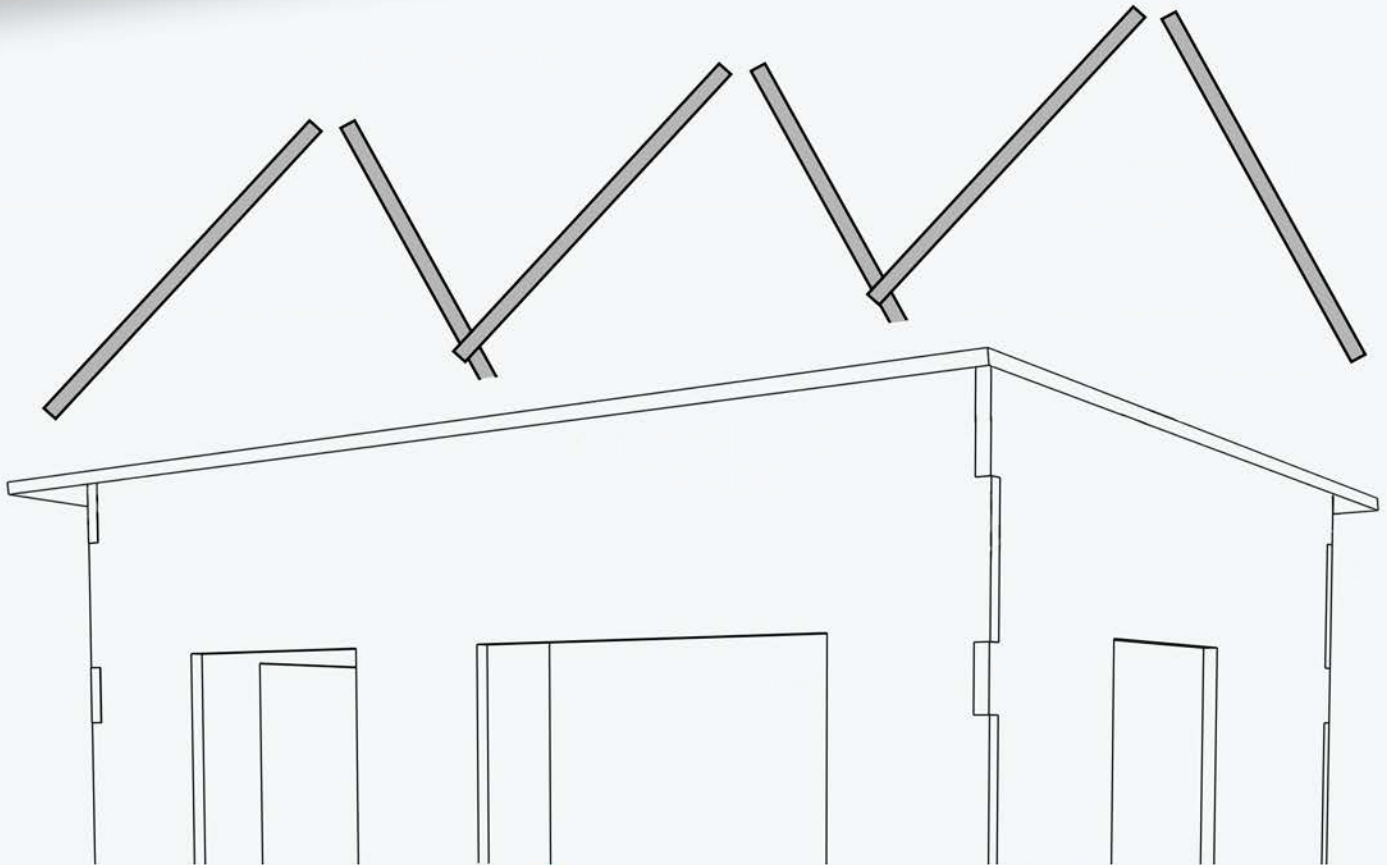
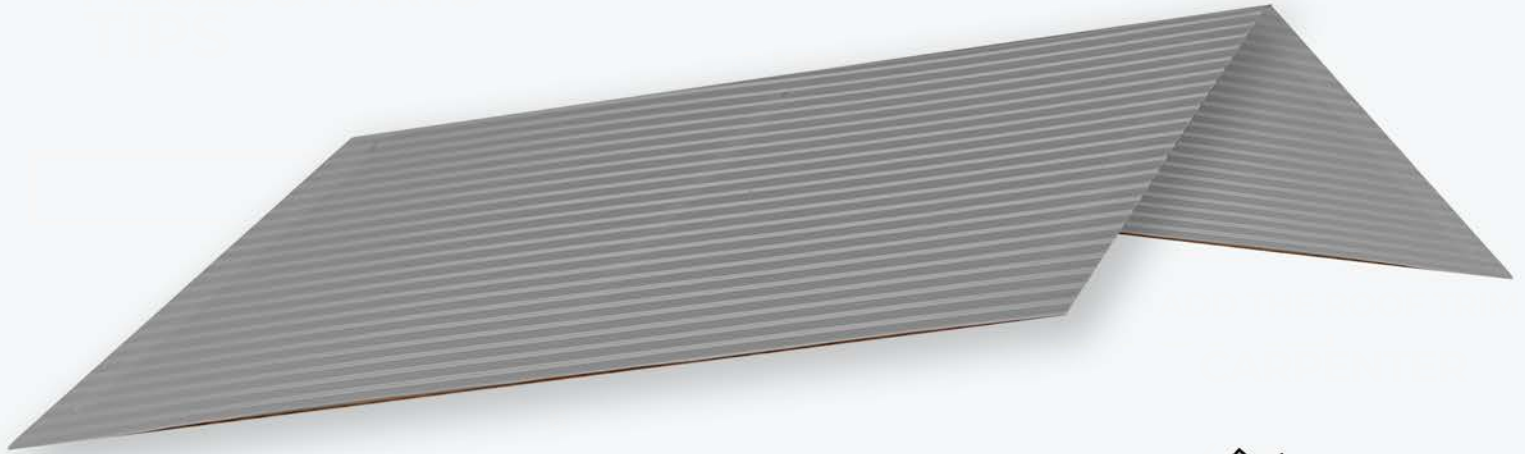

11



**ATTACH TIN ROOF
TO THE I-BEAMS**

**SHEET METAL
WORKER**



**PLEASE
WEAR GLOVES
WHEN USING
SUPER GLUE**



Nova Scotia
Construction Sector Council
Industrial ~ Commercial ~ Institutional

TRADES EXHIBITION HALL

CONSTRUCTION KIT
INSTRUCTION MANUAL
PAGE 9

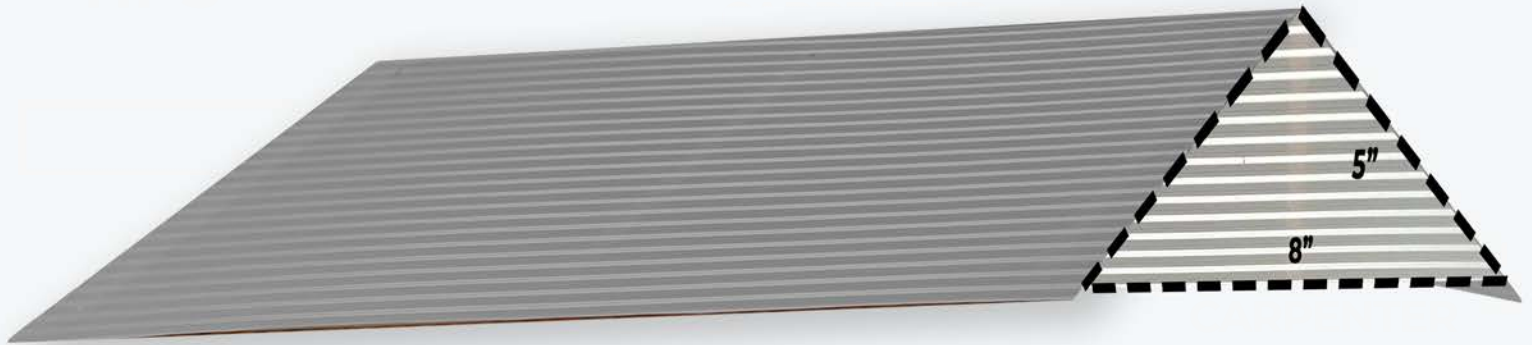

12



**ADD THE ROOF
INSERTS**

**SHEET METAL
WORKER**

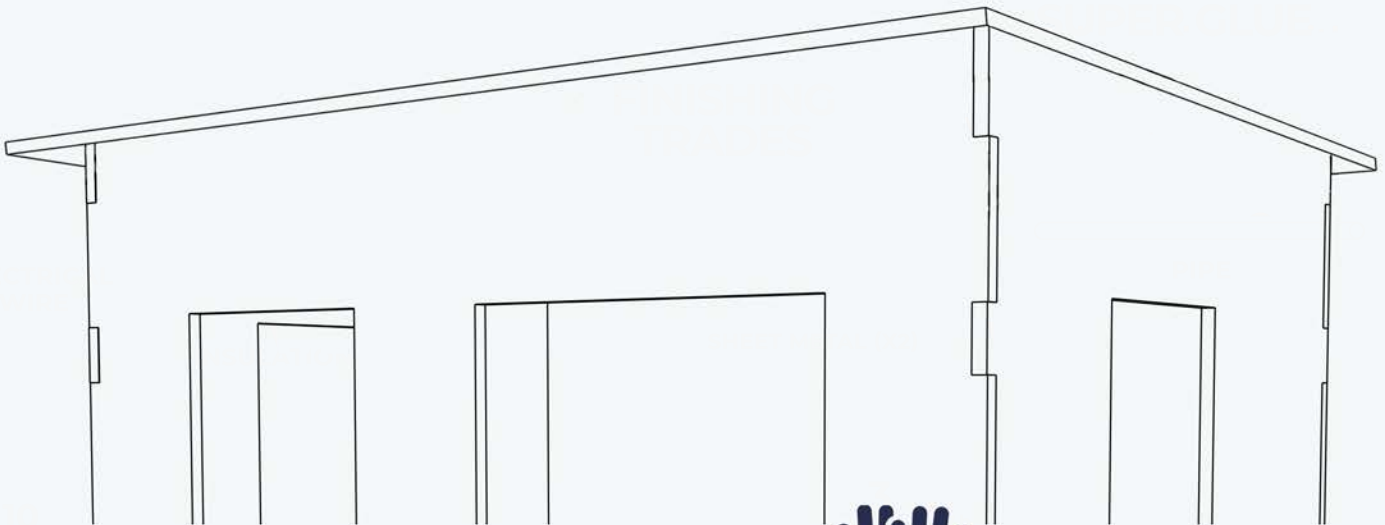

**PLEASE
WEAR GLOVES
WHEN USING
SUPER GLUE**



Nova Scotia
Construction Sector Council
Industrial ~ Commercial ~ Institutional

TRADES EXHIBITION HALL

CONSTRUCTION KIT
INSTRUCTION MANUAL
PAGE 10

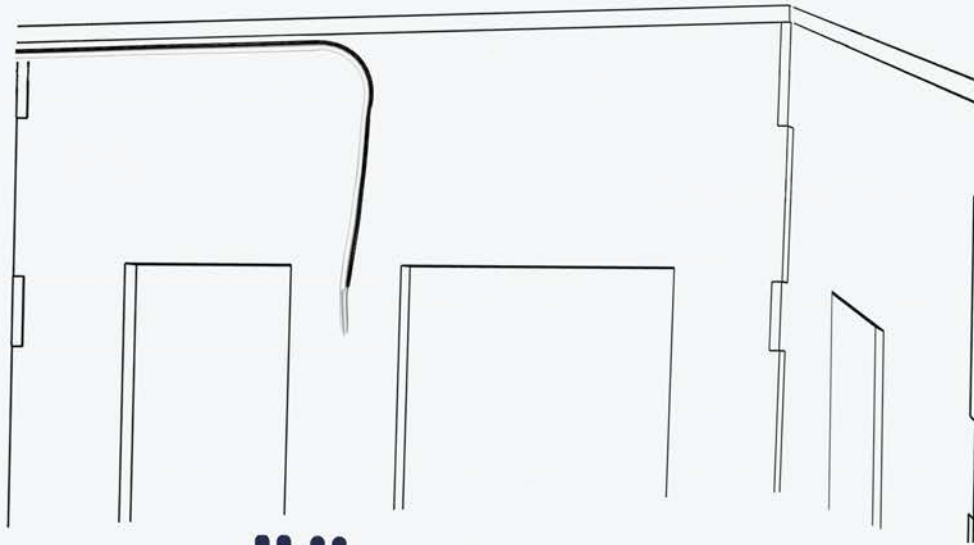

13



**ADD ELECTRICAL
WIRE**
ELECTRICIAN



**PLEASE
WEAR GLOVES
WHEN USING
SUPER GLUE**

14



ADD PIPE
PIPE TRADES

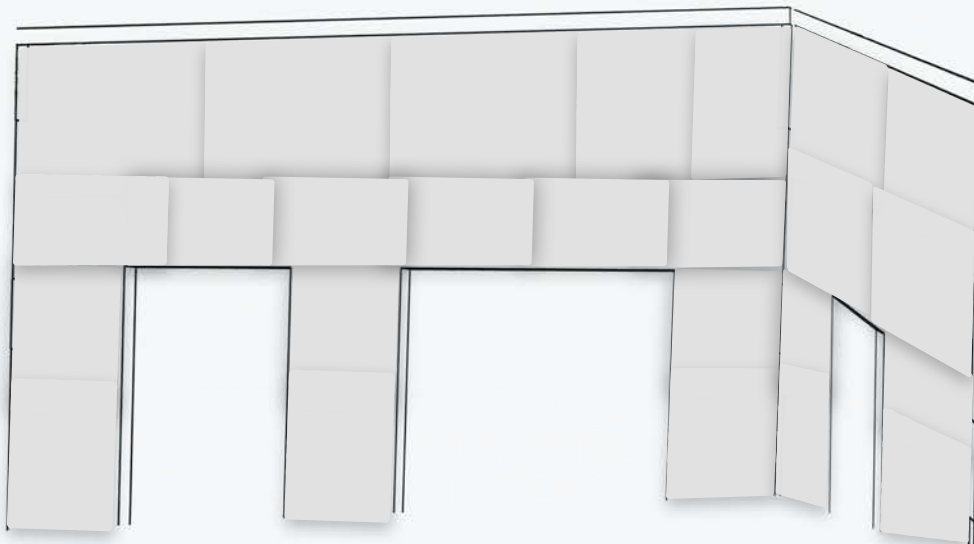
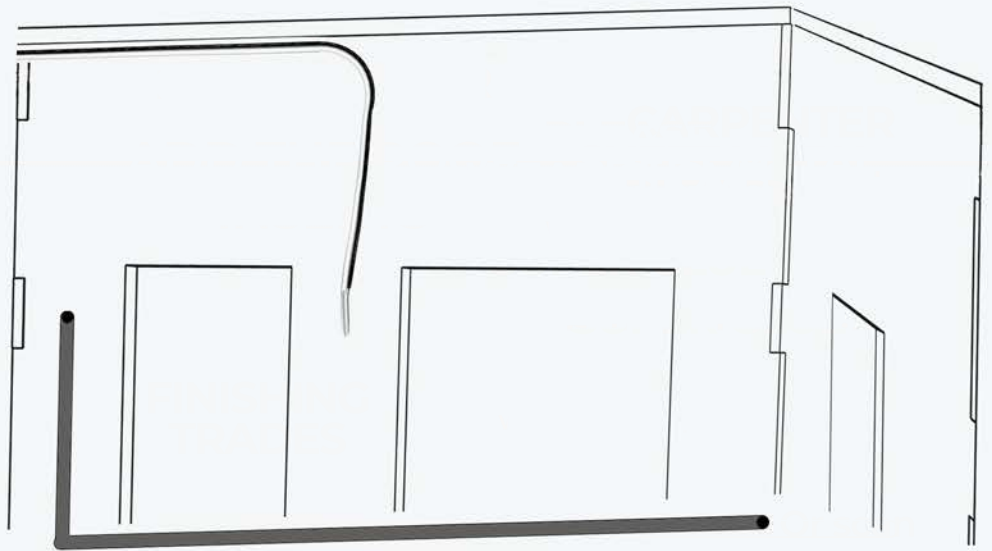

15



ADD INSULATION
INSULATOR

COMMERCIAL RETAIL AREA COMPLETE!



SNAP A PIC OF YOUR BUILD AND TAG US ON SOCIAL MEDIA!

@nscsc_ici #TEHConstructionKit



Nova Scotia
Construction Sector Council
Industrial ~ Commercial ~ Institutional



NOVA SCOTIA
APPRENTICESHIP
AGENCY